

Analysis of Multi-Path Channels Using the WLAN Packet Preamble

Alper Akbilek, Dr. Florian Pfeiffer, Manzar Hussain
perisens GmbH

Agenda

1. About perisens
2. Motivation
3. Background
4. Implementation and Results
5. Conclusion

Agenda

1. About perisens
2. Motivation
3. Background
4. Implementation and Results
5. Conclusion

About perisens...

perisens GmbH

Founded in 2009 as Spin-Off from the **Technical University of Munich(TUM)** with ongoing cooperation

Services

- Technical Consulting / Studies
- RF measurements & Simulations (up to 90 GHz)
- Development and Evaluation of Wireless Communication Systems
- Signal Processing
- Development of RF Prototypes
- Solutions in Automotive Radar Sensors

Products

- In-House Development, Production and Sale of Radar Target Simulators (RTS)



Agenda

1. About perisens
2. Motivation
3. Background
4. Implementation and Results
5. Conclusion

Motivation

- Wifi is everywhere
- Higher data rates enabled by new amendments
- High data rates require very favorable channel conditions
- Evaluating the wireless channel is required to determine if implementing new wireless standards (e.g IEEE 802.11ax) would bring improvement

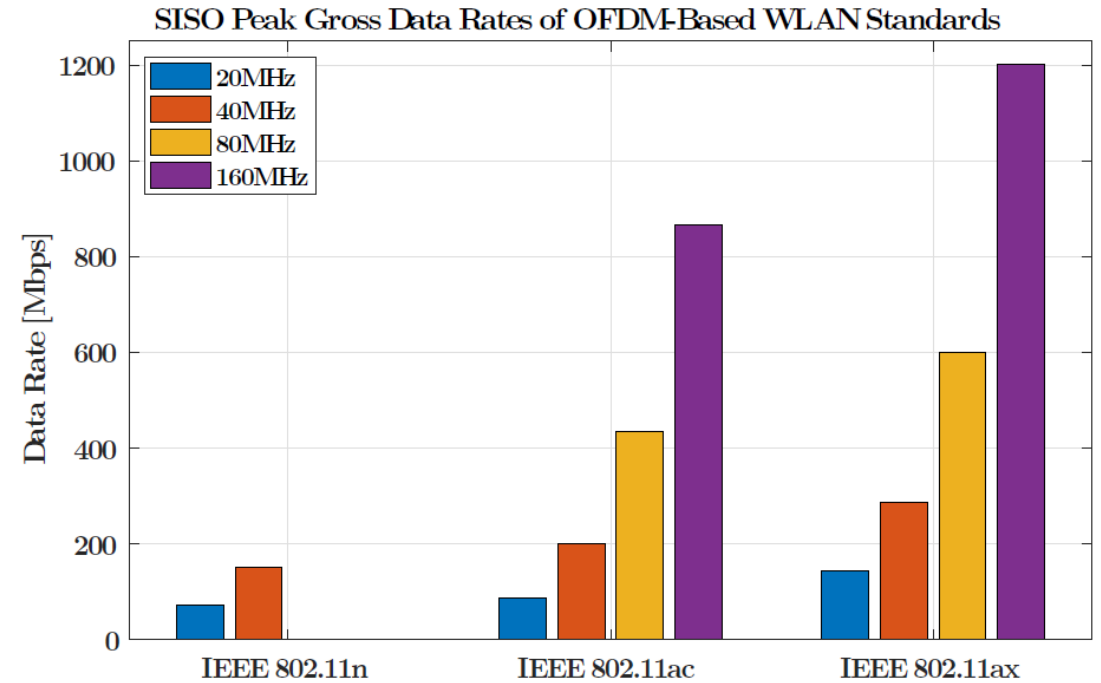

Goal: Evaluating IEEE 802.11ax (Wi-Fi 6) without Commercial WLAN Hardware

- Matlab models allow evaluation of WLAN standards before commercial hardware hits the market
- We aim to evaluate the standard for specific environment (e.g. in-vehicle environments)
- Simulations and over-the-air testing with Matlab
 - IEEE 802.11ax models are available in MATLAB WLAN Toolbox since 2018

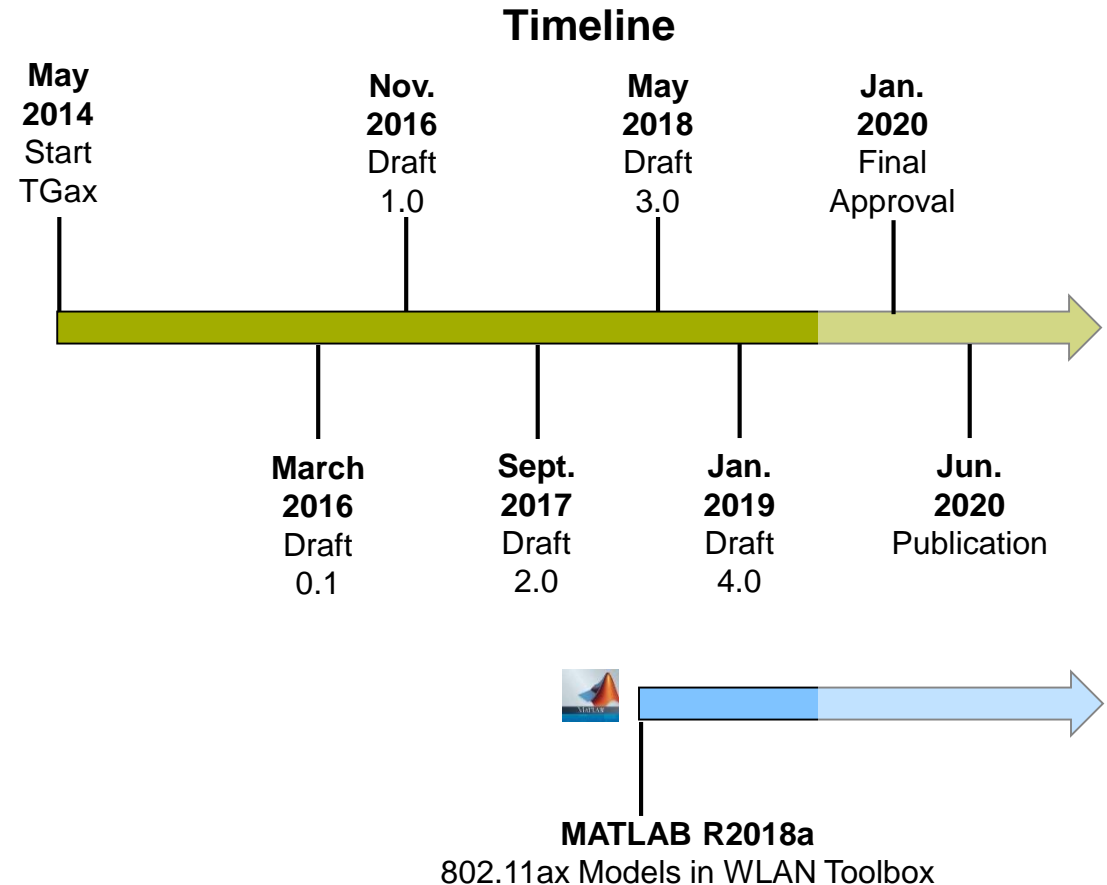

Agenda

1. About perisens
2. Motivation
3. Background
4. Implementation and Results
5. Conclusion

OFDM

- Orthogonal frequency-division multiplexing
- Data is transmitted over independent sub-carriers with some redundancy (channel coding)
- Able to cope with severe channel conditions (frequency-selective fading, narrowband interference...)

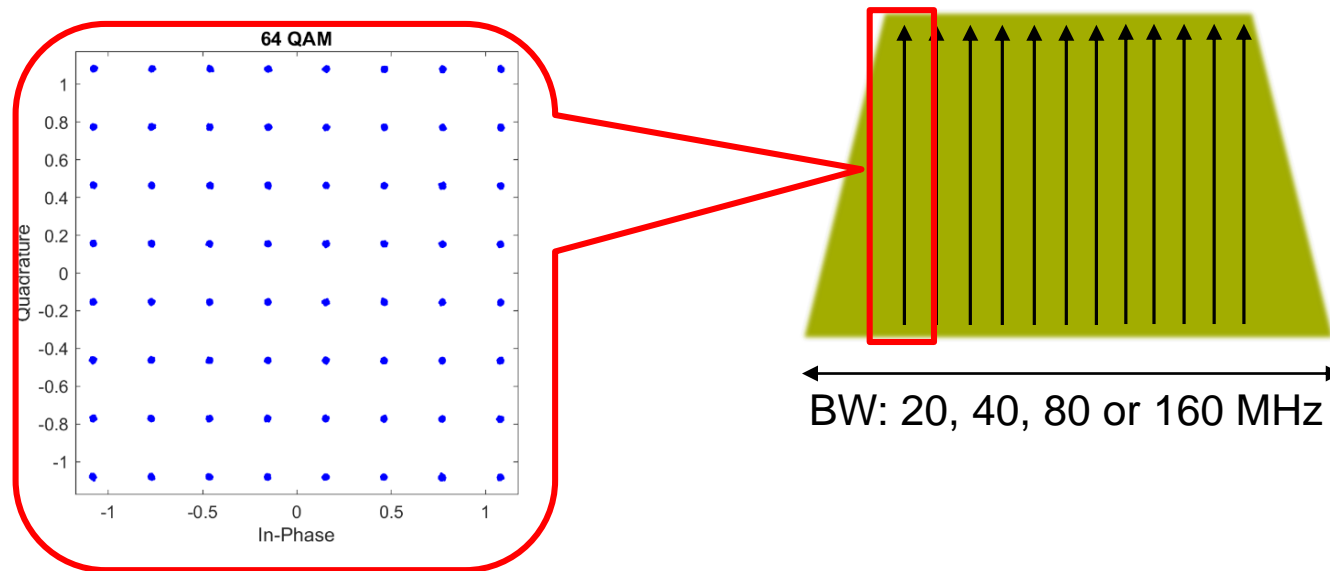

WLAN sub-carrier distance:

IEEE 802.11a/g/n/ac: 312.5 kHz
 IEEE 802.11ax : 78.125 kHz

Enabling High Throughput Higher Modulation and Coding Schemes

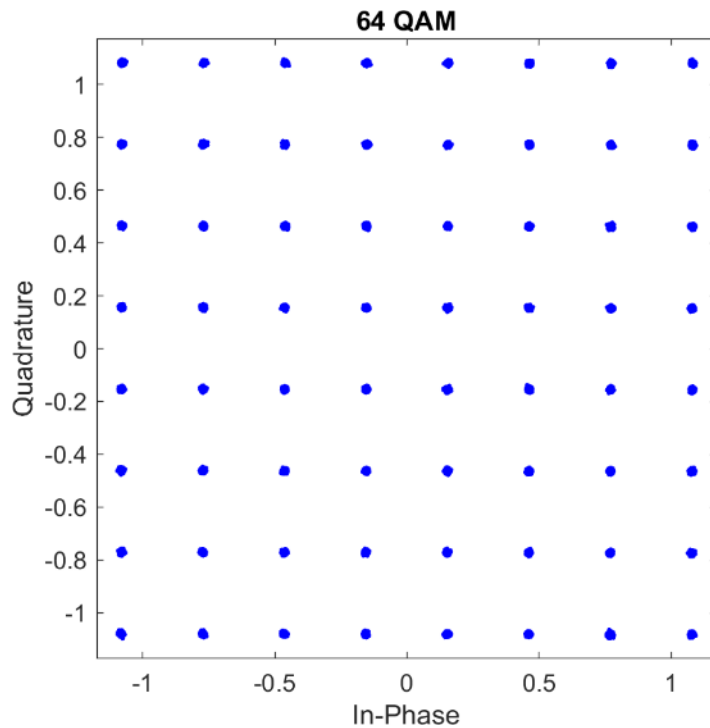

6 Bits/Symbol/Carrier
MCS 5,6,7
IEEE 802.11a/g/n

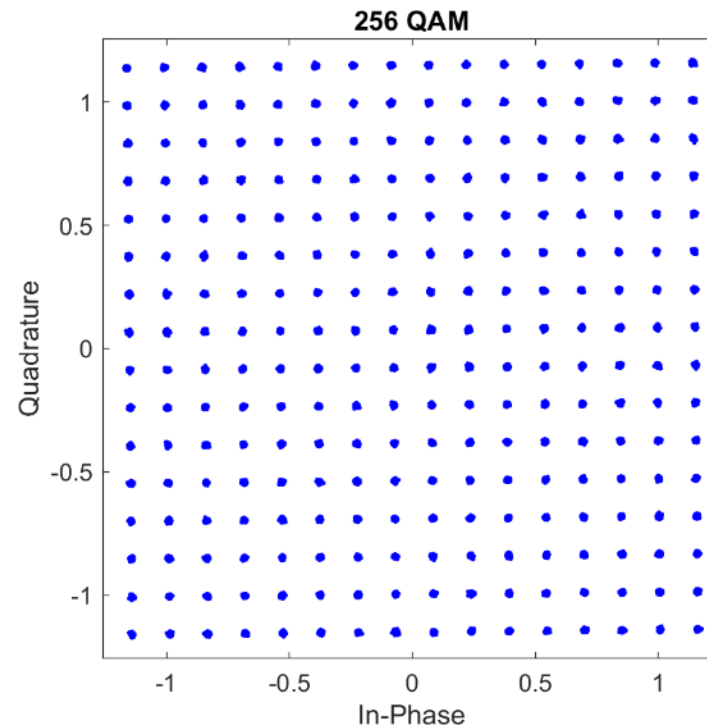

8 Bits/Symbol/Carrier
MCS 8,9
IEEE 802.11ac

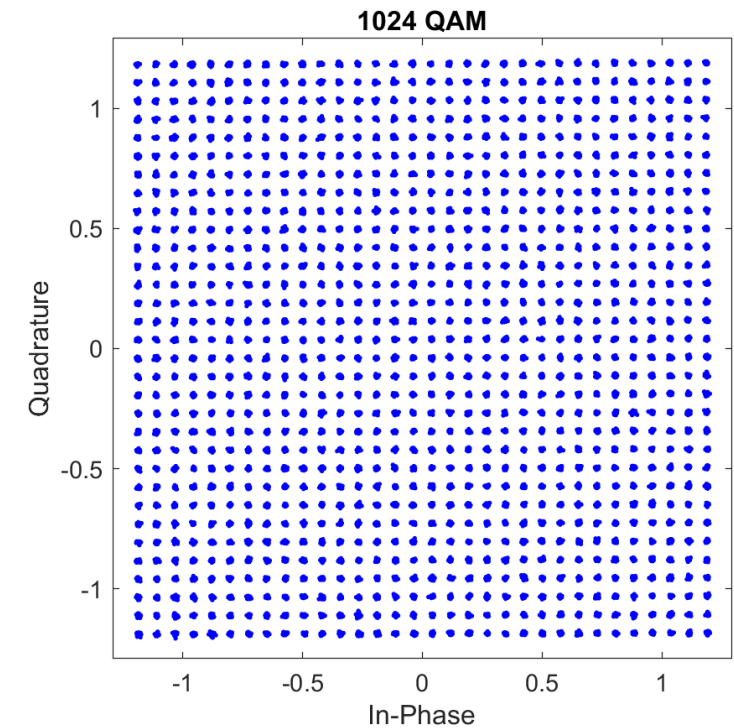

10 Bits/Symbol/Carrier
MCS 10,11
IEEE 802.11ax

Received Signal Strength

- Total received signal power in the channel
- Available at the receiver
- Conventional way to evaluate the link
- High data rates require high signal power at the receiver
- **Signal strength is NOT the only factor determining the link speed**

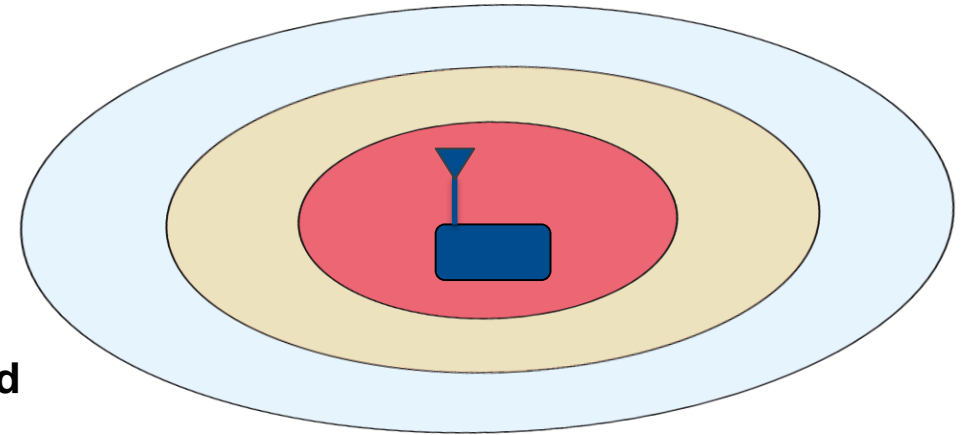

Multi-Path Channel

- Several echoes of the signal is detected at receiver
- Signal power and SNR are not equally distributed in the channel
- Causes frequency-selective fading which increases the required SNR
- Sensitive to moving objects on the signal path
- Channel models available for IEEE 802.11 simulations

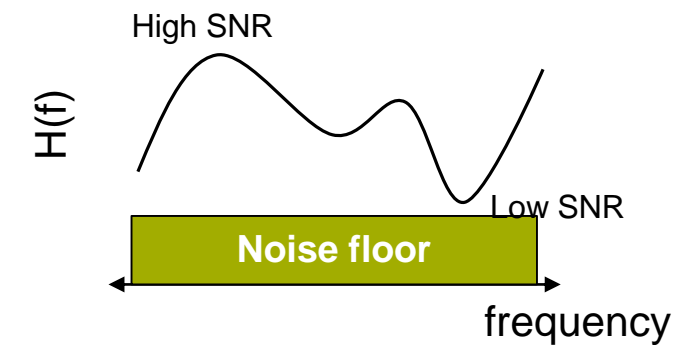
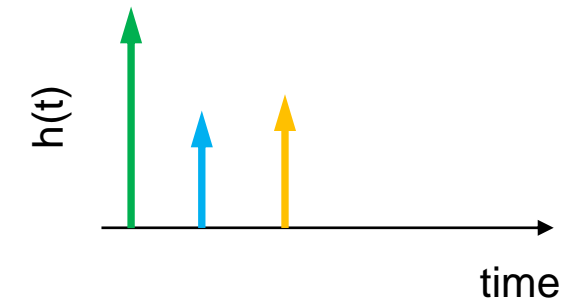
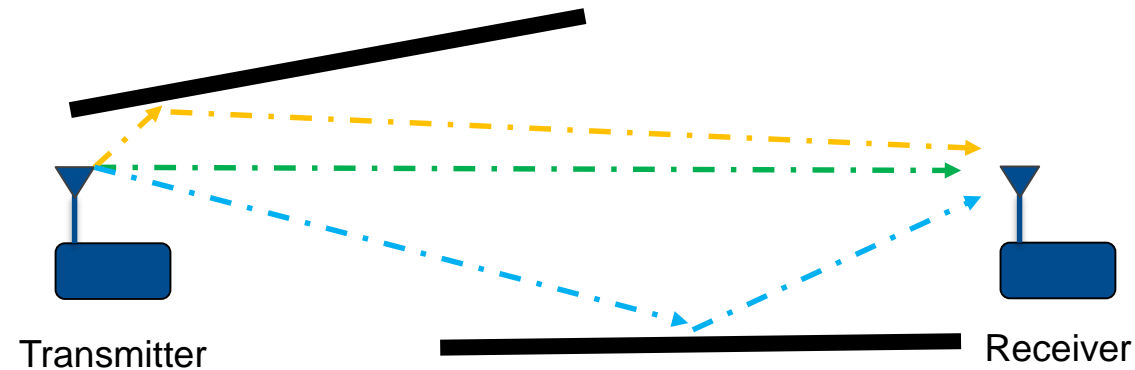

IEEE 802.11 Packet Preamble

Channel Estimation by HE-LTF for Equalization

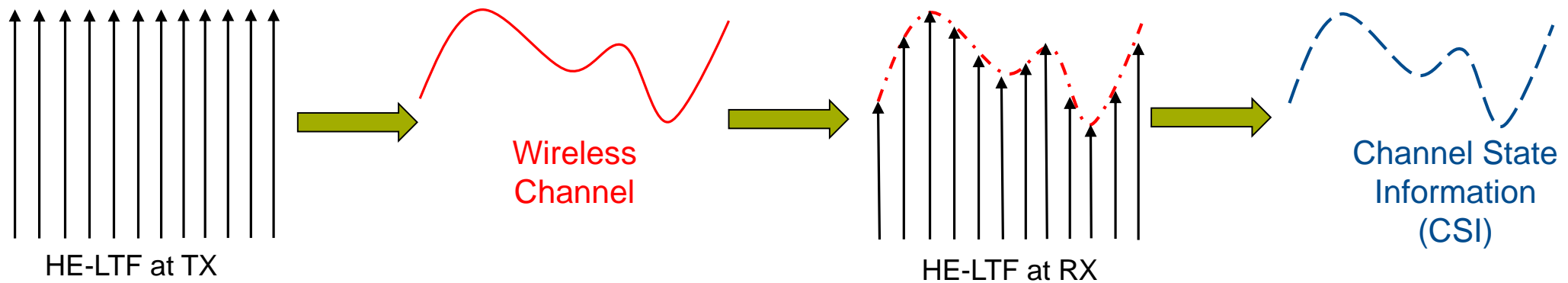
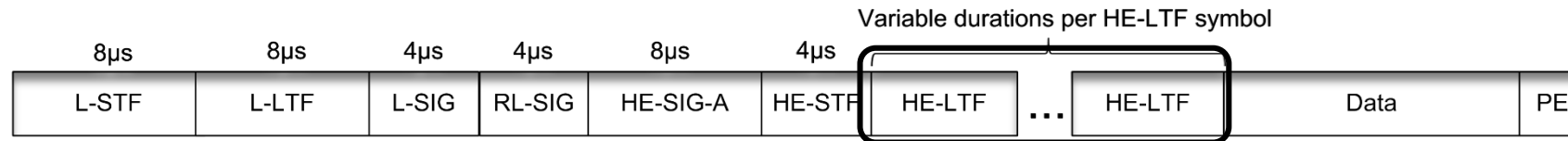

Agenda

1. About perisens
2. Motivation
3. Background
4. Implementation and Results
5. Conclusion

WLAN PHY Simulations in MATLAB

- Simulation loop is already included in MATLAB WLAN Toolbox
- IEEE channel models available for example scenarios (small office, conference room etc.)
- Output: SNR requirement for a definite WLAN packet format
- We use simulations for link budget calculations for specific scenarios in which the path loss is known

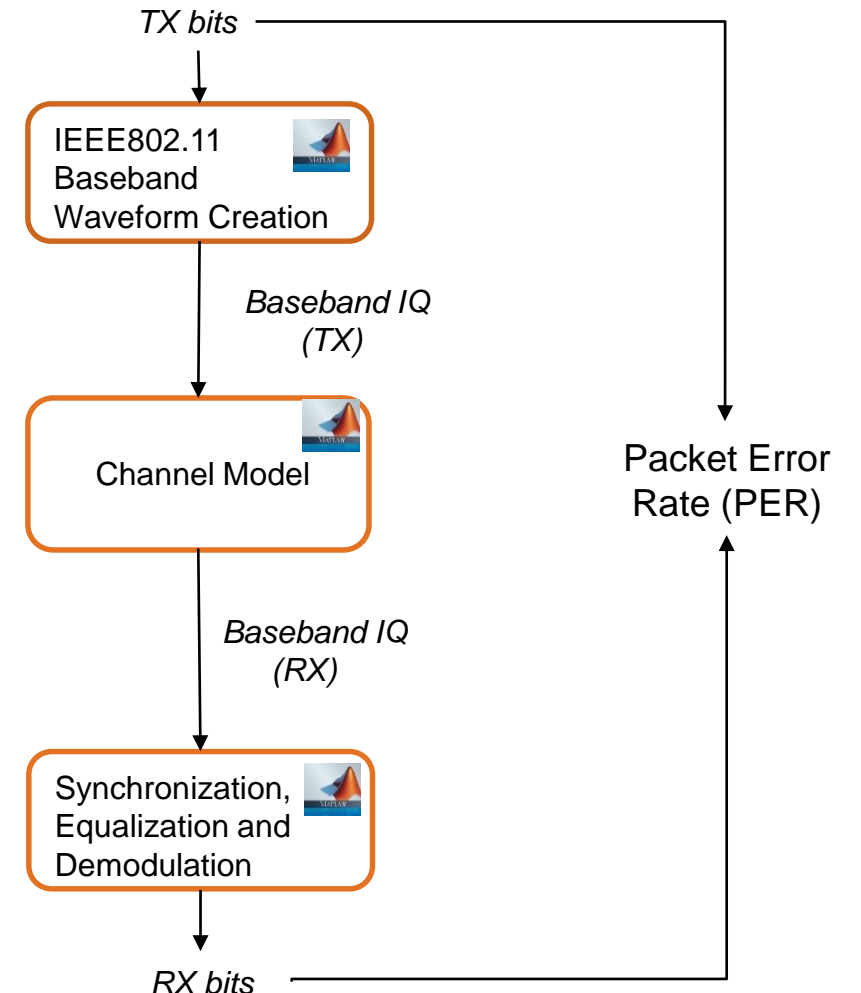

Opening the Simulation Loop Measurements Over the Air

- Sending WLAN packets over the RF channel
- Evaluate the real wireless channel
- Requires RF instruments or Software-Defined-Radios (SDRs) as TX and RX
- Can measure the PER for a definite packet type
- **Drawback:** Long measurement time

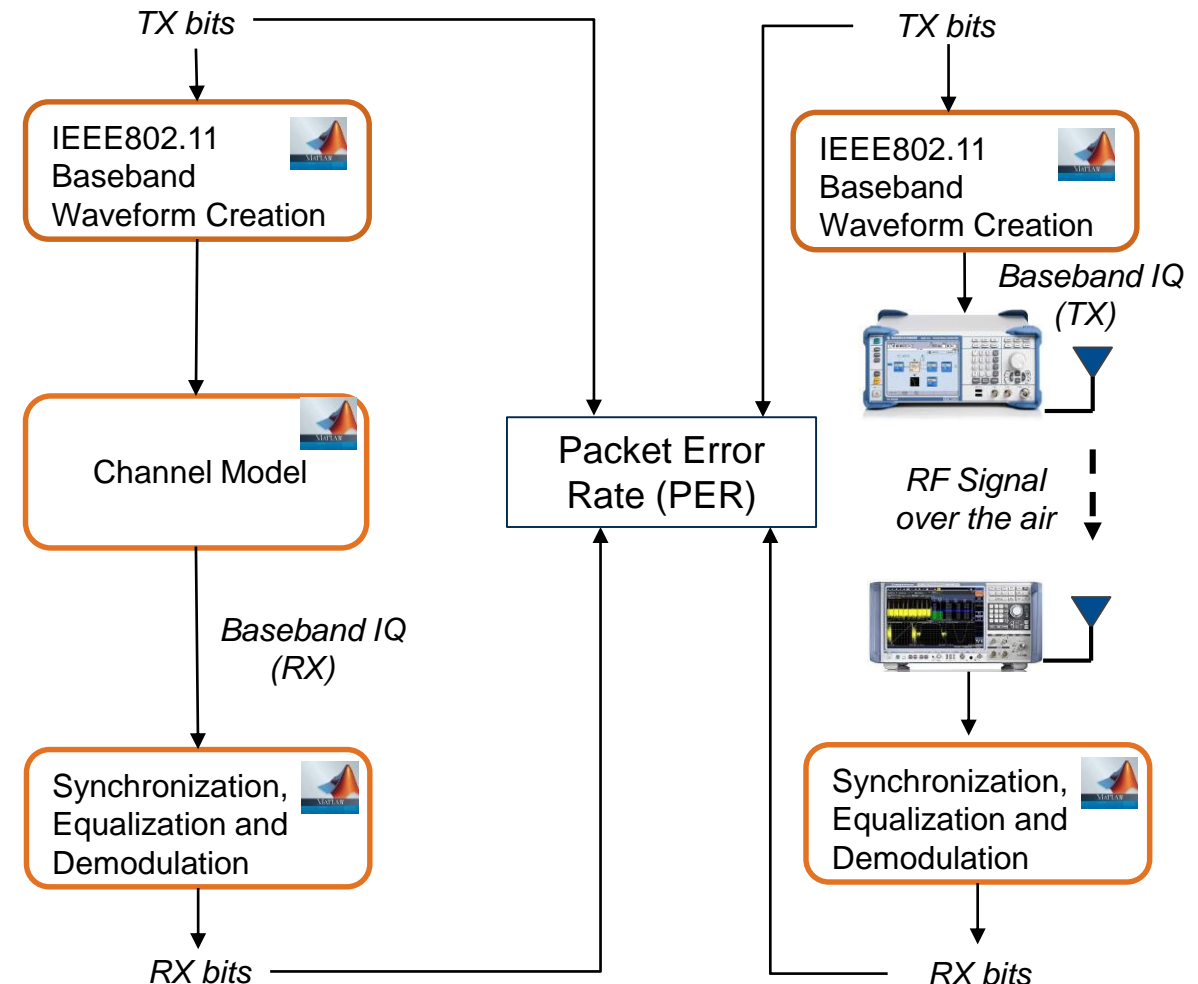

Channel Sounding

Extracting the Channel State Information (CSI)

- Instead of making PER measurements, we only extract the Channel State Information (CSI) and signal power
- We collect several CSI samples to use in simulations
- Packet type & modulation are varied in simulations to determine the highest achievable data rates

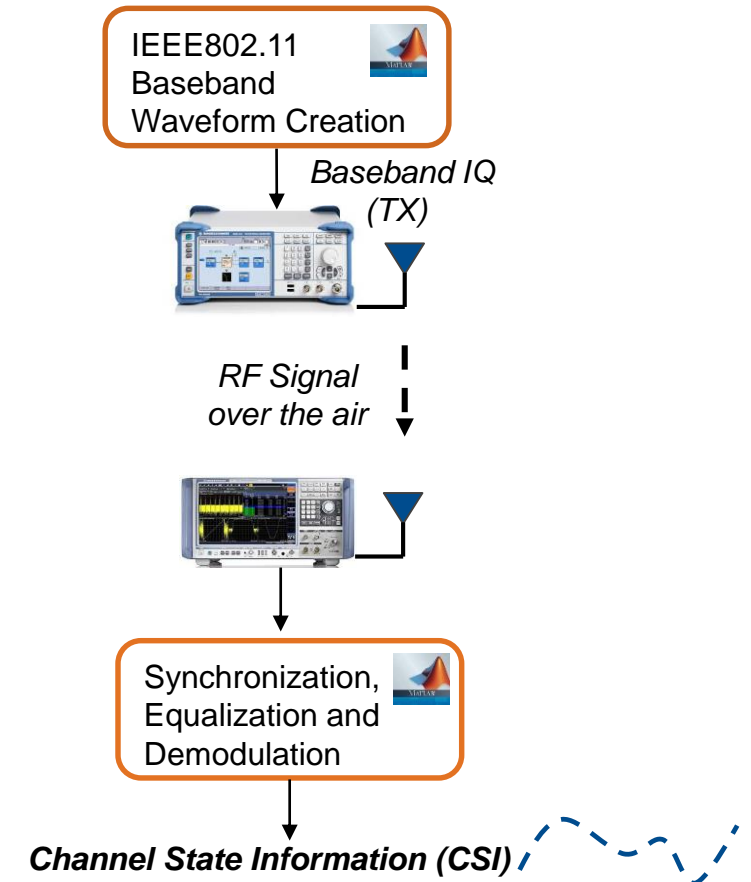

Channel Sounding Method Using the CSI in Simulations

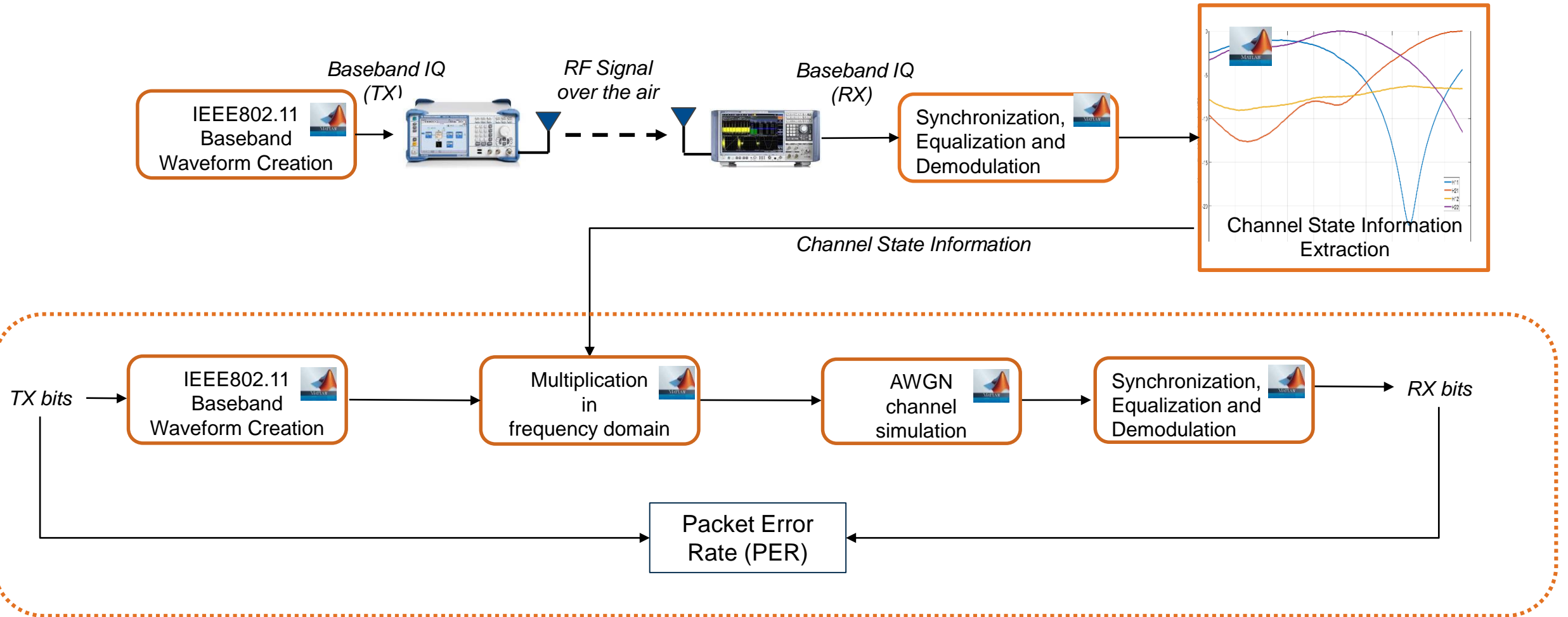

Channel Frequency Response & Error Vector Magnitude (EVM)

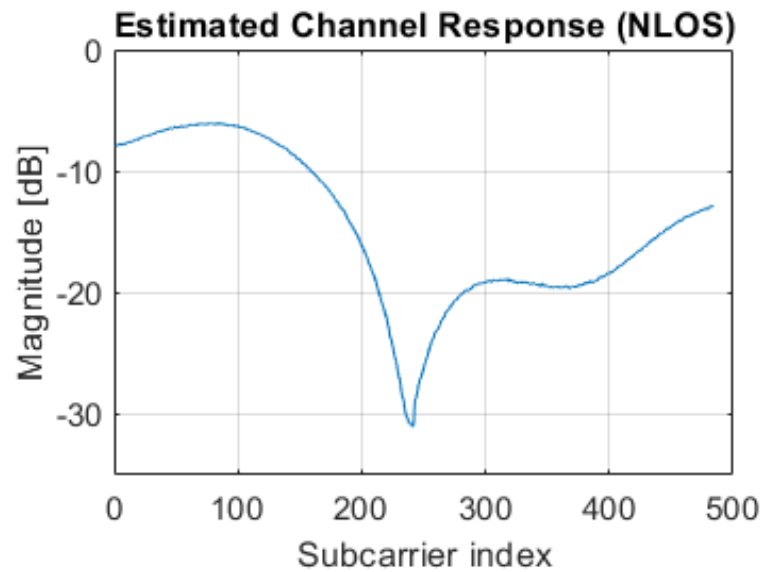

Simulation using
the measured
channel response

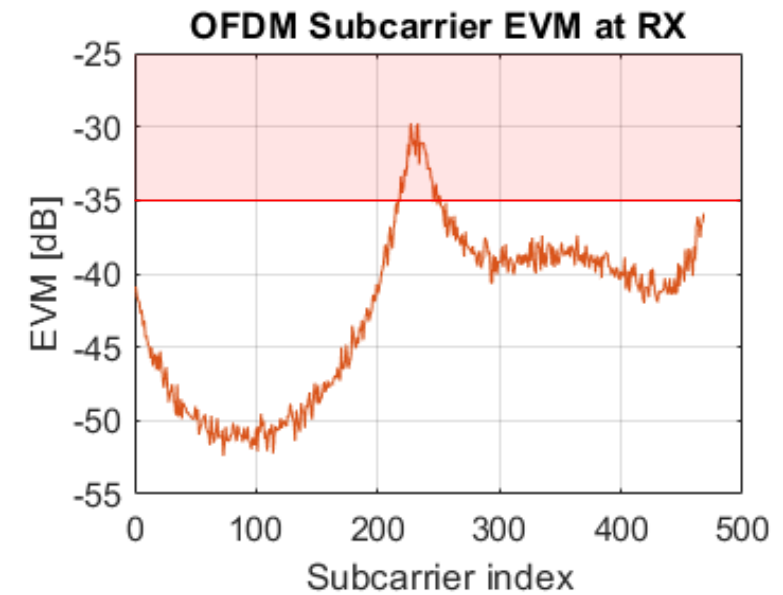

EVM threshold
for 1024-QAM:
-35 dB

Channel Sounding with WLAN Packets Measurement Setup

- Measurement in a closed room
- IEEE 802.11ax waveforms generated in MATLAB
- First transmission with line of sight channel
 - Measured path loss: 53 dB
- Second transmission with non line of sight channel
 - Measured path loss: 59 dB

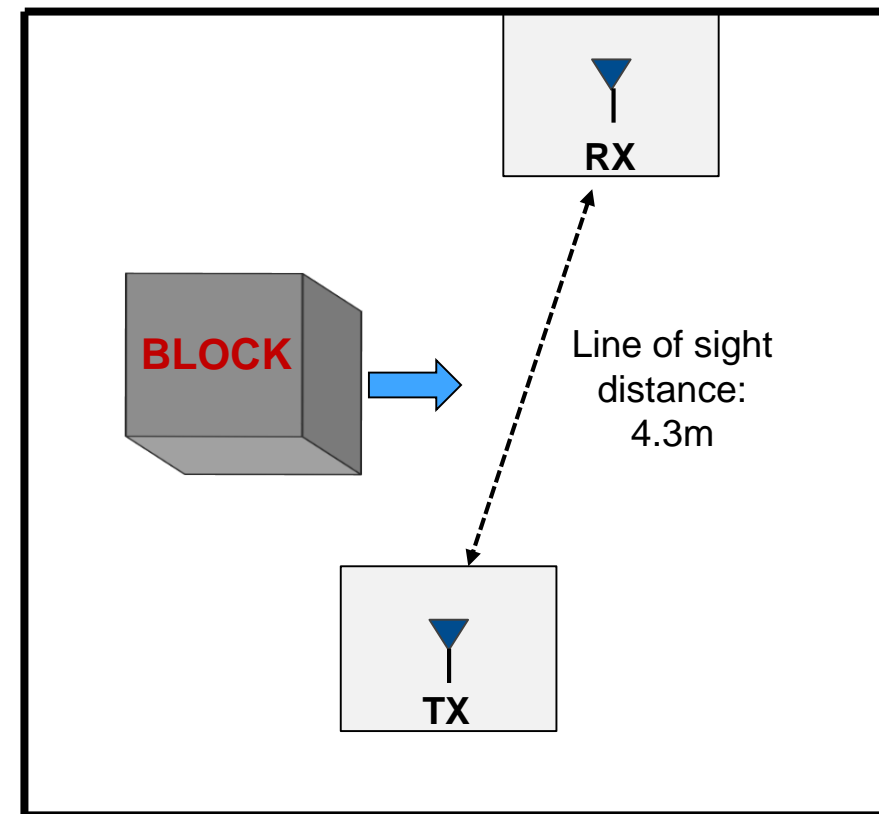

Channel Sounding with WLAN Packets Measurement Setup

- Measurement in a closed room
- IEEE 802.11ax waveforms generated in MATLAB
- First transmission with line of sight channel
 - Measured path loss: 53 dB
- Second transmission with non line of sight channel
 - Measured path loss: 59 dB

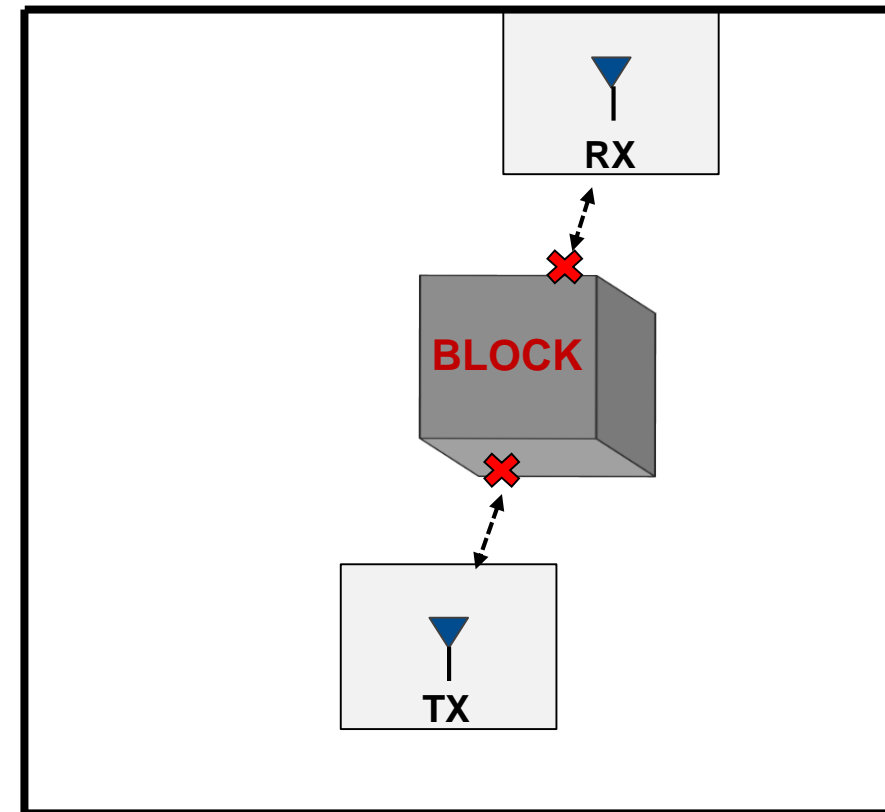

Channel Sounding with WLAN Packets

Results

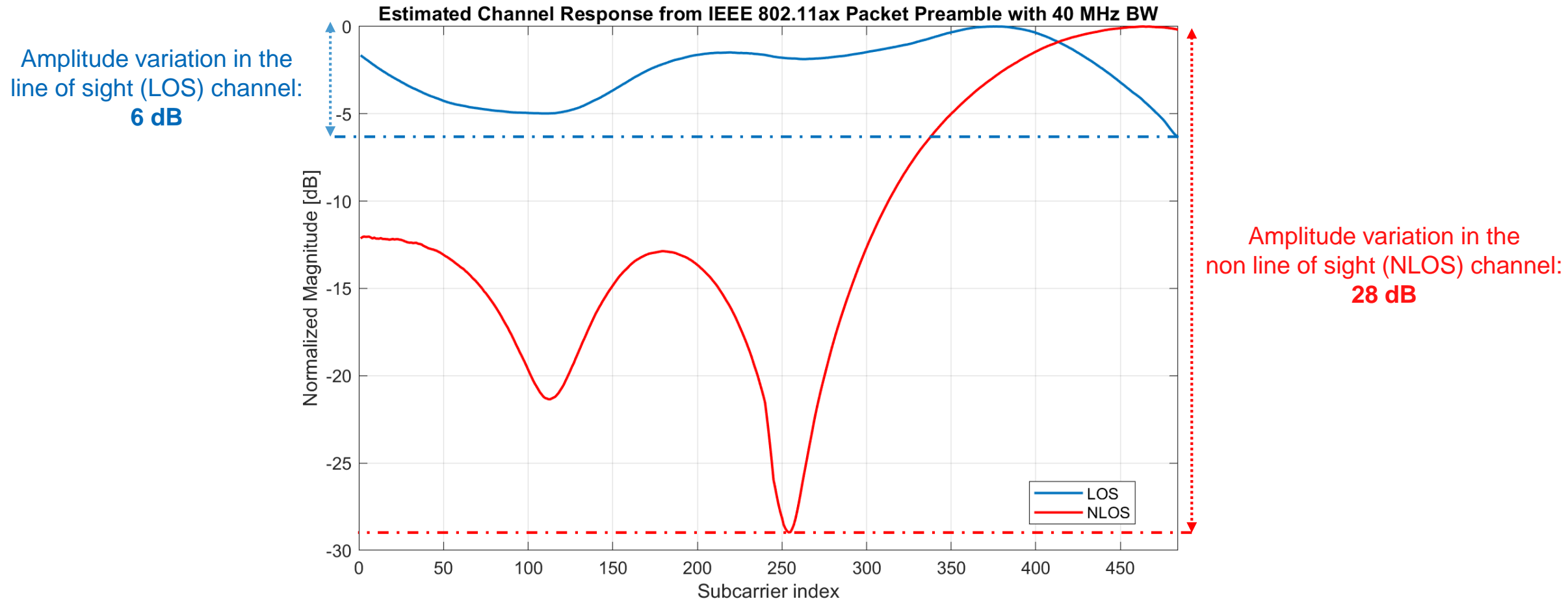

Simulation Using the LoS and NLoS Channel Responses Results

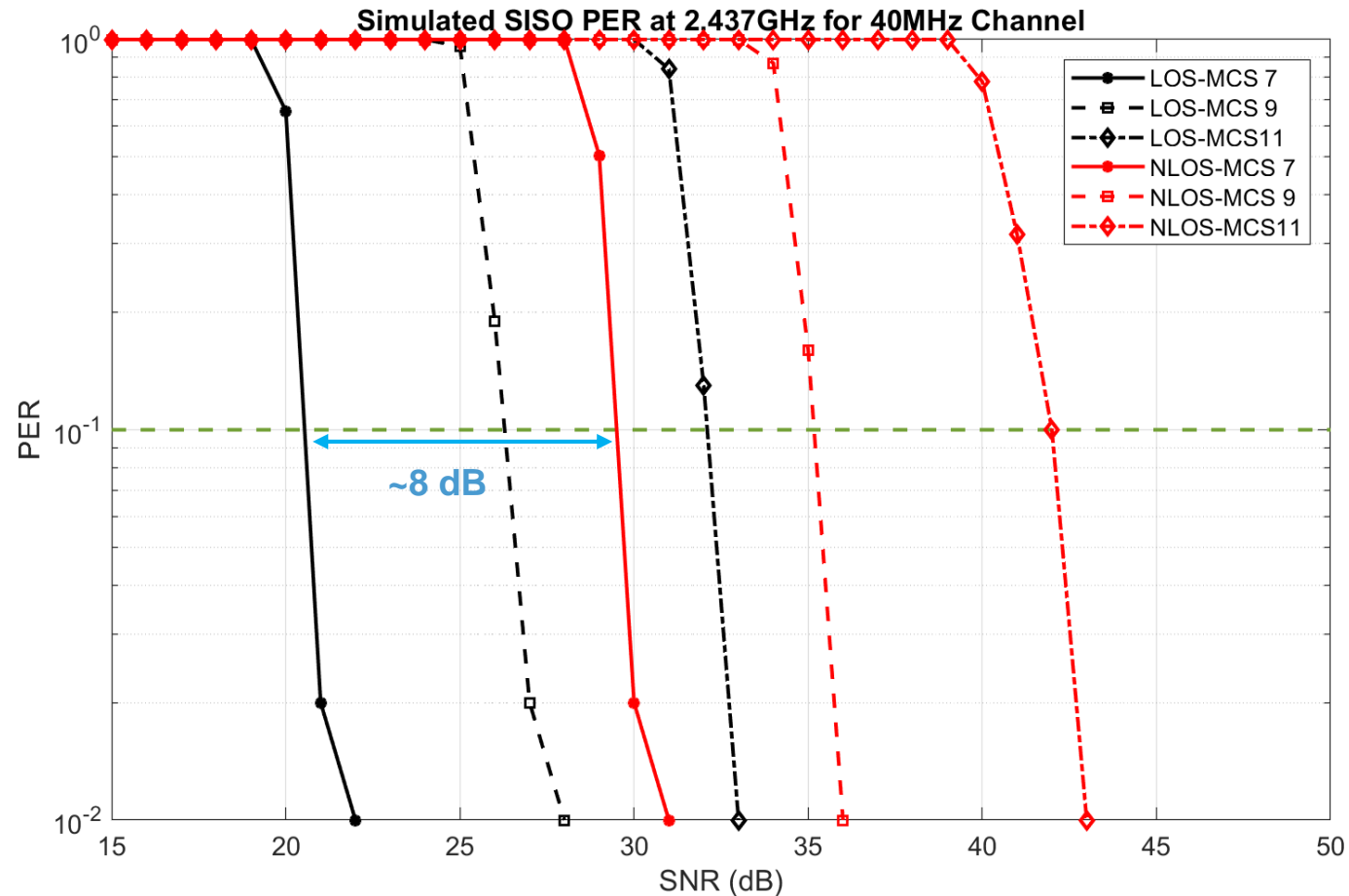

Agenda

1. About perisens
2. Motivation
3. Background
4. Implementation and Results
5. Conclusion

Conclusion

Summary

- New wireless standards can be evaluated with MATLAB before the hardware hits the market
- Wireless channels can be analyzed using the WLAN signals
- Energy is not evenly distributed in a non line of sight (NLOS) channel
- Receiver needs higher signal power to decode the signal in NLOS scenarios
- The channel state information (CSI) changes if there are moving objects in the room

Future Work

- Other applications using the channel state information (CSI) of WLAN signals:
 - Human presence detection
 - Vital signal monitoring (breathing & heart rate)